



SPECIFICATION

FOR APPRONAL

Customer : _____

Product Name : Receiver _____

Model Name : VS0842R32 _____

Drawing No. : VS20190921013 _____

Signature of Voise

Approved by	Checkde by	Issued by	Date



福爱斯电子有限公司
VOISE ELECTRONICS CO.,LTD.

Office Add:Haoyangguang B-302# No.968 Baizhang Road,Ningbo China
Factory add: Shishan Industrial Park Moushan Town Yuyao City China
Tel:86-0574-87471601 Fax:86-0574-87471603 P.C.315000
Http://www.nbvoise.com E-mail:sales@nbvoise.com



Receiver		Page	3/7
Model No.:	VS0842R32	Revision No.	1.0
		Drawing No.	VS20190921013

1. Scope

This document contains required environmental, electrical, acoustic, mechanical, package and reliability test requirement

2. General Characteristics

- 2.1 Out-Diameter : 8 mm
- 2.2 Height : 4.2 mm
- 2.3 Weight : 0.6 g
- 2.4 Operating Temperature : -20~+50°C without loss of function
- 2.5 Store Temperature : -20~+60°C without loss of function

3. Electrical and Acoustic Characteristics.

Test condition : 15 ~ 35 °C Temp., 25% ~ 75% RH, 86~106 kPa Refer to IEC60268-1

No	Items	Specification
1	Impedance	32 Ω ± 15% (1Vrms at 1.2KHz)
2	Sound Pressure Level	97 dB ± 3dB (1mW at 1kHz)
3	Resonance Frequency(fo)	500 Hz ± 20% without baffle 0.25V
4	Frequency Range	500Hz ~20KHz
5	Input Power	Rated 0.003 W / Max. 0.005 W
6	Distortion	Less than 5% at 1kHz/2Vrms
7	Buzz and Rattle	Should not be audible buzzes,rattles when the 0.31V sine wave signal swept at frequency range.
8	Polarity	When a positive DC current is applied to the voice coil terminal marked (+) , the diaphragm shall move to forward.

Receiver		Page	5/7
Model No.:	VS0842R32	Revision No.	1.0
		Drawing No.	VS20190921013

4. Measurement Method & Frequency Response curve

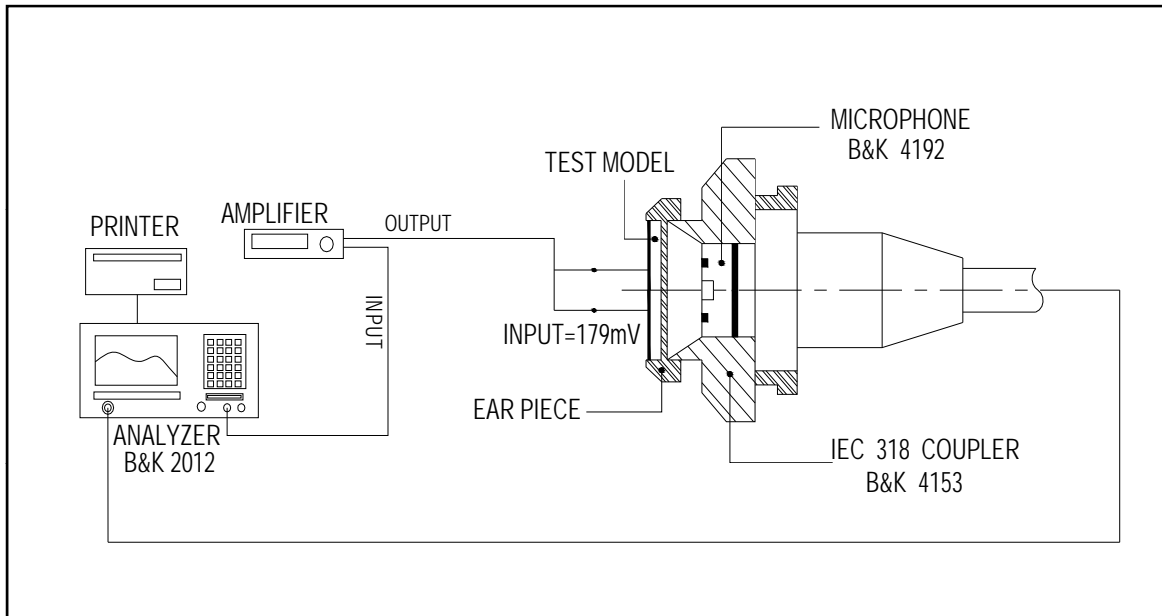

Receiver		Page	6/7
		Revision No.	1.0
Model No.:	VS0842R32	Drawing No.	VS20190921013

5. Dimensions

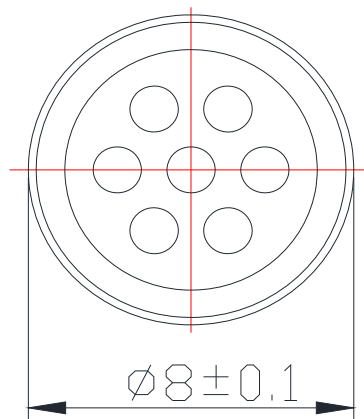
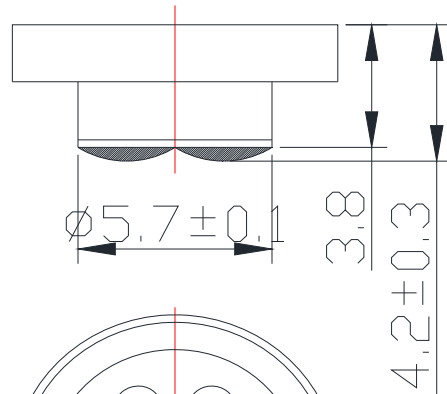
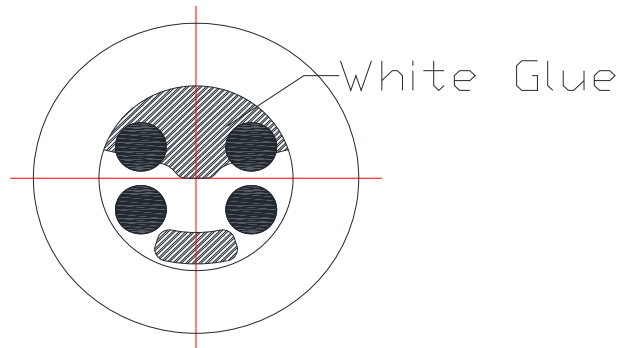

FIRST ANGLE PROJECTION

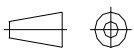

UNIT : mm

Tolerance : ± 0.2